

FCC NOTICE (Class A)

This device complies with Part 15 of the FCC Rules. Operation is subject to the following two conditions: (1) this device may not cause harmful interference, and (2) this device must accept any interference received, including interference that may cause undesired operation.

NOTE- This equipment has been tested and found to comply with the limits for a Class A digital device, pursuant to Part 15 of the FCC Rules. These limits are designed to provide reasonable protection against harmful interference when the equipment is operated in a commercial environment. This equipment generates, uses, and can radiate radio frequency energy and, if not installed and used in accordance with the instructions, may cause harmful interference to radio communications. Operation of this equipment in a residential area is likely to cause harmful interference in which case the user will be required to correct the interference at his own expense.

CAUTION ON MODIFICATIONS

To comply with the limits for the Class A digital device, pursuant to Part 15 of the FCC Rules, this device must be installed in computer equipment certified to comply with the Class A limits. All cables used to connect the computer and peripherals must be shielded and grounded. Operation with non-certified computers or non-shielded cables may result in interference to radio or television reception.

Changes and modifications not expressly approved by the manufacturer could void the user's authority to operate this equipment.

European Community Compliance Statement (Class A)

This product is conformity with the protection requirements of EU Council Directives 89/336/EEC amended by 92/31/EEC on the laws of the Member States relating to electromagnetic compatibility.

Warning - This is a Class A product. In a domestic environment this product may cause radio interference in which case the user may be required to take adequate measures to correct this interference.

DISCLAIMER

No warranty or representation, either expressed or implied, is made with respect to the contents of this documentation, its quality, performance, merchantability, or fitness for a particular purpose. Information presented in this documentation has been carefully checked for reliability; however, no responsibility is

assumed for inaccuracies. The information contained in this documentation is subject to change without notice.

In no event will AVerMedia be liable for direct, indirect, special, incidental, or consequential damages arising out of the use or inability to use this product or documentation, even if advised of the possibility of such damages.

TRADEMARKS

AVerMedia is registered trademarks of AVerMedia TECHNOLOGIES, Inc. IBM PC is a registered trademark of International Business Machines Corporation. Macintosh is a registered trademark of Apple Computer, Inc. Microsoft is a registered trademark and Windows is a trademark of Microsoft Corporation. All other products or corporate names mentioned in this documentation are for identification and explanation purposes only, and may be trademarks or registered trademarks of their respective owners.

COPYRIGHT

© 2006 by AVerMedia TECHNOLOGIES, Inc. All rights reserved. No part of this publication may be reproduced, transmitted, transcribed, stored in a retrieval system, or translated into any language in any form by any means without the written permission of AVerMedia TECHNOLOGIES, Inc.



THE MARK OF CROSSED-OUT WHEELED BIN INDICATES THAT THIS PRODUCT MUST NOT BE DISPOSED OF WITH YOUR OTHER HOUSEHOLD WASTE. INSTEAD, YOU NEED TO DISPOSE OF THE WASTE EQUIPMENT BY HANDING IT OVER TO A DESIGNATED COLLECTION POINT FOR THE RECYCLING OF WASTE ELECTRICAL AND ELECTRONIC EQUIPMENT. FOR MORE INFORMATION ABOUT WHERE TO DROP OFF YOUR WASTE EQUIPMENT FOR RECYCLING, PLEASE CONTACT YOUR HOUSEHOLD WASTE DISPOSAL SERVICE OR THE SHOP WHERE YOU PURCHASED THE PRODUCT.

Table of Contents

Introduction.....	E-1
Package Contents	E-1
Optional Accessories.....	E-2
AVerVision300AF Parts	E-3
Technical Specifications.....	E-4
Making the Connections.....	E-5
Connecting the Power Adapter	E-6
Connecting a TV	E-6
Connecting a VGA, Mac Display Monitor or LCD/DLP Projector	E-7
Connecting a Computer via USB Connection.....	E-8
Installing the Optional Light Box	E-9
Connecting to a Microscope	E-9
Setting Up AVerVision300AF	E-10
Camera Head	E-10
Mechanical Arm	E-10
LED Light Module	E-11
Anti-glare Sheet.....	E-11
Using the Infrared Remote Control	E-12
Touch Button Control Panel.....	E-14
LED Panel.....	E-15
Timer Function.....	E-16
Transferring the captured image from AVerVision300AF to Computer	E-16
OSD Navigation Tree	E-17
Menu Functions	E-18
RS-232C Diagram Connection	E-20
RS-232C Cable Spec	E-21
RS-232C Transmission Spec.....	E-21
RS-232C Communication Format.....	E-21
RS-232C Command Table.....	E-21
Troubleshooting	E-22
Limited Warranty	E-23

Introduction

Thank you for purchasing the AVerMedia® AVerVision300AF. This document camera displays any documents, negatives, transparencies and 3D objects onto a TV, LCD or DLP projector making presentations a snap.

AVerVision300AF is an ideal presentation tool for business, academic, medical and the scientific community.

AVerMedia

Package Contents

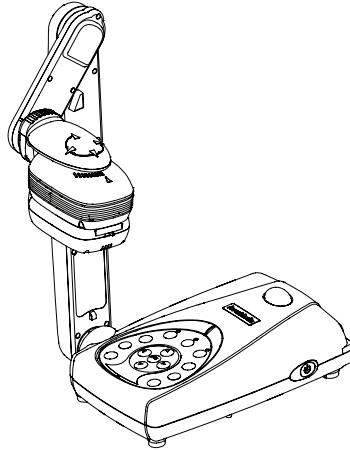

AVerMedia® AVerVision300AF

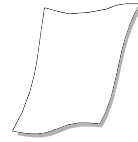

Anti-glare Sheet



Carrying Bag



User Manual



Remote Control
(batteries included)

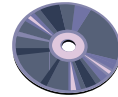

Driver CD

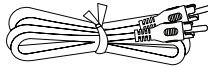

RCA Cable

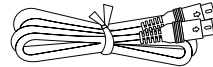

S-Video Cable

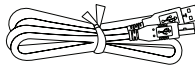

USB Cable

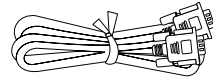

Computer Extension cable
(VGA Cable)

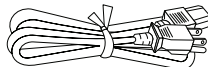

Power Cord

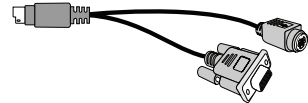

S-Video/RS-232 Cable

* The power cord will vary depending on the standard power outlet of the country where it is sold.

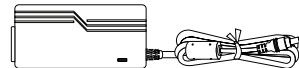

Power Adapter

Optional Accessories

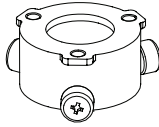

34mm Microscopic Adapter

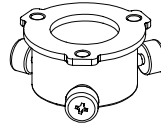

28mm Microscopic Adapter

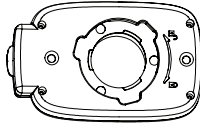

Microscopic Coupler

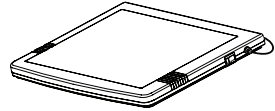

Light Box

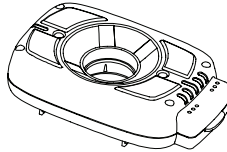

LED Lamp with Laser
Positioning Pointer

AVerMedia

AVerVision300AF Parts

The illustrations below identify the parts of AVerVision300AF.

- (1) Camera head
- (2) LED light module
- (3) Camera lens
- (4) Control panel
- (5) Arm
- (6) Left panel
- (7) IR sensor
- (8) Rear panel
- (9) Right panel
- (10) Power button
- (11) Antitheft Slot
- (12) DC 12V port
- (13) Light box power port
- (14) VGA output port
- (15) VGA input port
- (16) S-Video output port
- (17) Composite video output port
- (18) TV/RGB display switch
- (19) DVI output port
- (20) USB port

AVerMedia

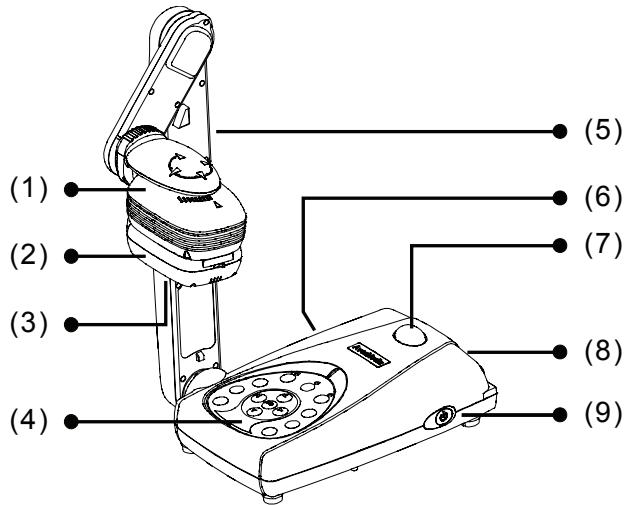

Right Panel

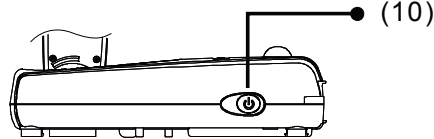

Rear Panel

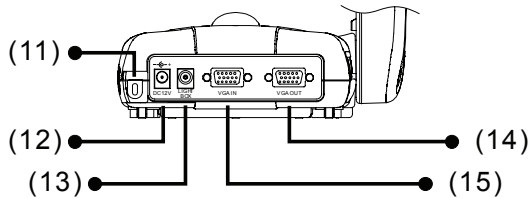

Left Panel

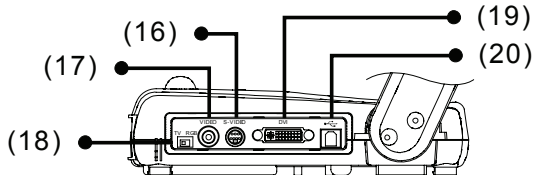

Technical Specifications

Image

Sensor	1/2" progress scan CMOS
Total Pixels	3.2 mega pixel
Frame Rate	24 fps (Max.)
White Balance	Auto / Manual
Exposure	Auto / Manual / Flicker / Night View
Image Mode	Text / Graphics / High Frame
Effect	Color / B/W / Negative; Reverse; Mirror
Analog RGB Output	XGA : 60 Hz, SVGA : 60 Hz, VGA : 60 Hz
S-Video, Composite Video Output	NTSC or PAL
Image Capture	Up to 80 Frames
Built-In Memory	32MB NAND Flash Memory

Optics

Lens	F3.0; Auto Focusing
Shooting Area	320mm x 240mm (Max.);
Zooming	AVERZOOM: 2x, Digital: 8x

Power

Power Source	DC 12V, 1.2~ 4A, 100-240V, 50-60 Hz
Consumption	7.44 Watts (Lamp off); 10.68 Watts (Lamp on)

Lighting

Lamp Type	LED lamp
-----------	----------

Input/Output

VGA Input	15-Pins D-sub (VGA)
VGA Output	15-Pins D-sub (VGA)
DVI Output	DVI type
S-Video	Mini-DIN Jack
Composite Video	RCA Jack
USB	USB2.0
DC 6V Output	Power Jack

Dimension

Operating	424mm x 173.4mm x 330mm
Folded	365mm x 173.4mm x 95.85mm
Weight	2 kg (about 4.4 lb)

Making the Connections

The ports on the back and side panel of the AVerVision300AF enable you to connect the unit to a computer, graphics display monitor or LCD/DLP projector, TV or other device. Illustrated below are the ports that are located at the back and side panel of the AVerVision300AF with their corresponding labels.

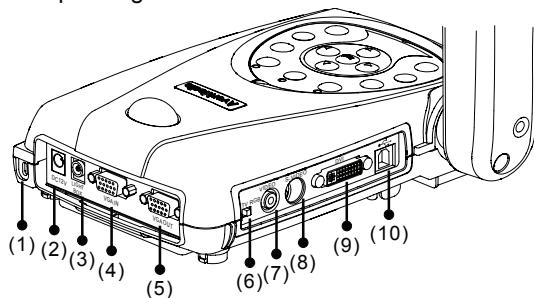

Port	Description
(1) Antitheft Slot	Attach a Kensington compatible security lock or antitheft device.
(2) DC 12V (input)	Connect the power adapter into this port.
(3) Light Box Port	Plug the optional light box into this port.
(4) VGA IN Port	Input RGB signal from a computer or other sources and actively pass it through to the VGA output port only. Connect this port to the VGA output port of the computer.
(5) VGA OUT Port	Output RGB signal from the camera, VGA input port, or the captured images from the memory on a VGA/Mac monitor or LCD/DLP projector.
(6) TV/RGB Switch	Set to select the between RGB (VGA Out) or TV (Composite Video/S-Video Out) display output.
(7) VIDEO Port (RCA/Composite)	Output the signal from the camera or the captured images from the built-in memory on TV or video equipment.
(8) S-VIDEO Port	Output the signal from the camera or the captured images from the memory on TV or video equipment.
(9) DVI Port	Output video signal from the camera, or the captured images from the memory on an LCD monitor or LCD/DLP projector with DVI interface.
(10) USB Port	Use AVerVision300AF as a USB Camera or Image Download allowing you to transfer the captured images to and from the AVerVision300AF built-in memory and PC.

Connecting the Power Adapter

Connect the power adapter to a standard 100V~240V AC power source.

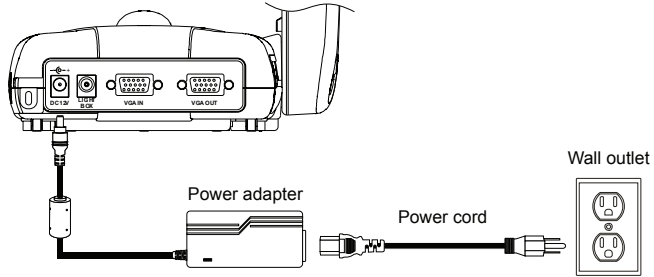

Connecting a TV

Locate the video, s-video or SCART RGB input port of the TV or Video equipment (i.e., VCR) to record your presentation on a videotape. If you are not sure, please refer to the user manual of the TV or Video equipment.



- Make sure the TV/RGB switch is set to TV.
- For better video quality, we strongly suggest using s-video connection.

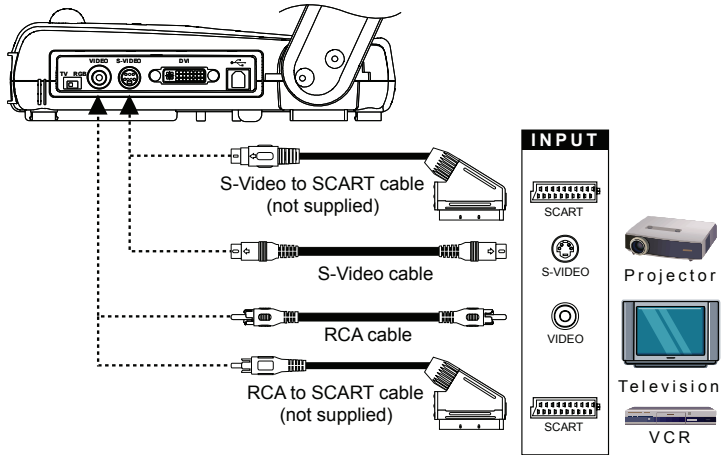

Connecting a VGA, Mac Display Monitor or LCD/DLP Projector

Locate the RGB (VGA) input port of the display device. If you are not sure, please refer to the user manual of the device.



Make sure the TV/RBG switch is set to RGB.

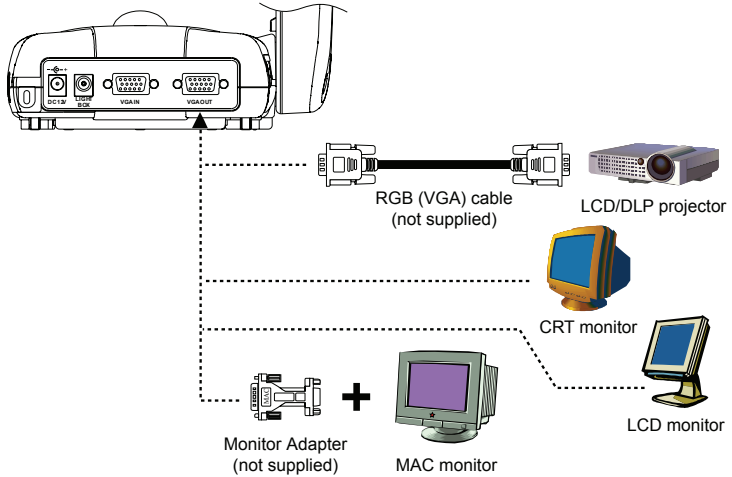

Connecting a VGA Monitor or LCD/DLP Projector with DVI interface

Locate the DVI input port of the display device. If you are not sure, please refer to the user manual of the device.



Make sure the TV/RBG switch is set to RGB.

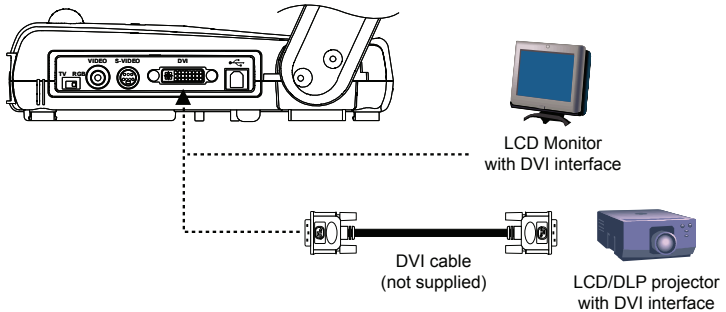

Connecting an IBM Compatible PC or Macintosh Computer

Locate the RGB video output port of the computer or laptop to display your PC presentation on screen. AVerVision300AF supports active pass-thru connectivity, wherein the video signal from the VGA input port is continuously streamed to VGA output port and displayed on screen even when the AVerVision300AF is turned off.

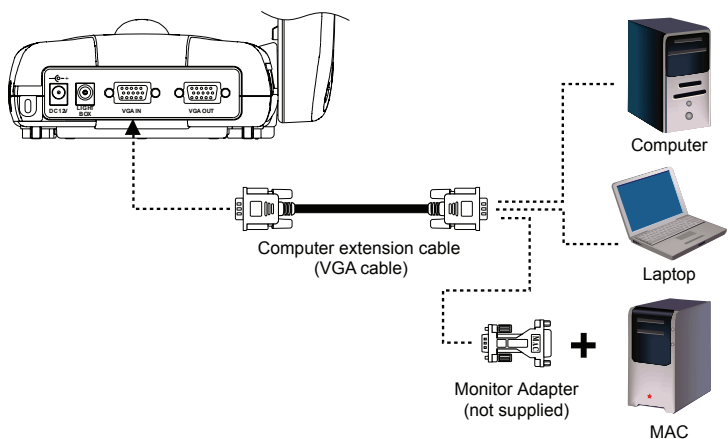

Connecting a Computer via USB Connection

Locate the USB port of the computer or laptop. This enables you to use AVerVision300AF as a USB Camera or to transfer the captured images from the built-in memory to your computer. Also see "Transfer Image from AVerVision300AF to PC" and refer to the bundled software user guide.

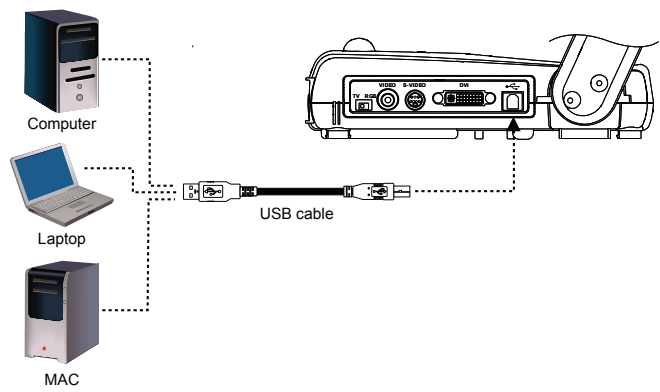

Installing the Optional Light Box

Connecting an optional light box enables you to view x-rays, transparencies and negative slides.

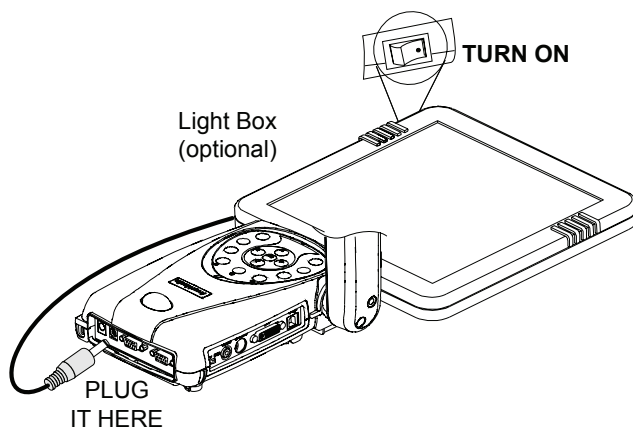

Connecting to a Microscope

Connecting the AVerVision300AF to a microscope enables you to examine microscopic objects on a big screen without straining your eyes.

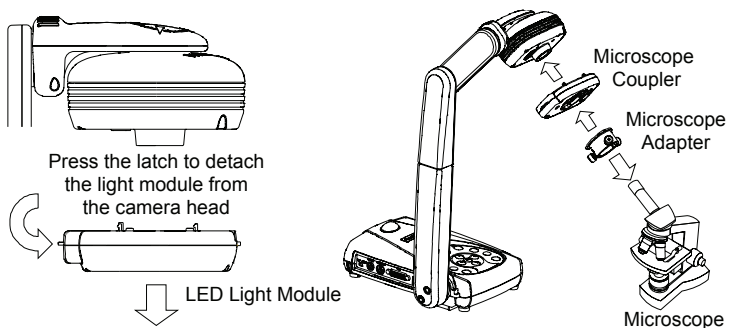

Setting Up AVerVision300AF

This section provides useful tips on how to adjust the AVerVision300AF to meet your needs.

Camera Head

The camera head can be rotated 135 degrees from left to right. You can also manually adjust the focus from here to improve the quality of the pictures.

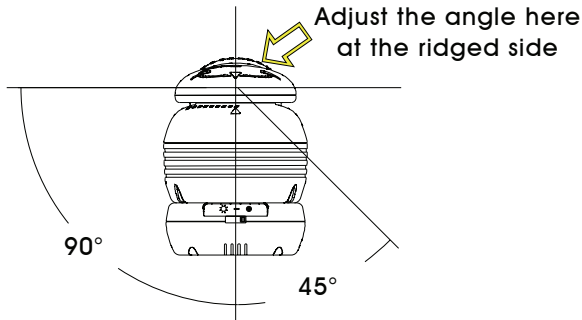

Mechanical Arm

The mechanical arm design allows you to project an image to its full height for full A4 paper landscape viewing.

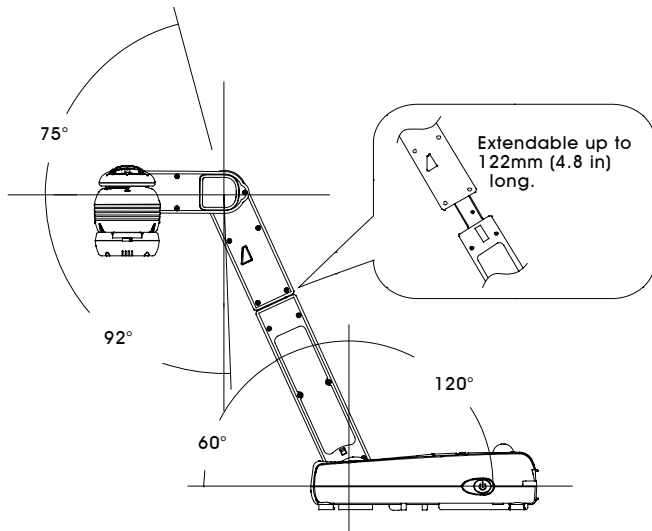

LED Light Module

The LED light module provides white light and it is best use when presenting in low lighting condition.

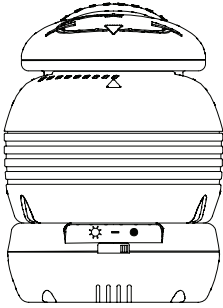

Turn On

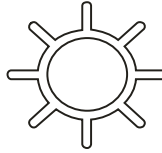

Turn Off



Anti-glare Sheet



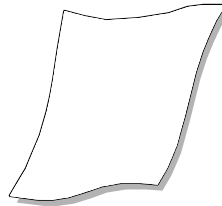

The anti-glare sheet is a special coated film that helps eliminate any glare you may encounter when you are displaying very shiny object or glossy surfaces such as magazines, pictures, etc. Simply place the anti-glare sheet on top of the shiny document to reduce reflected light.



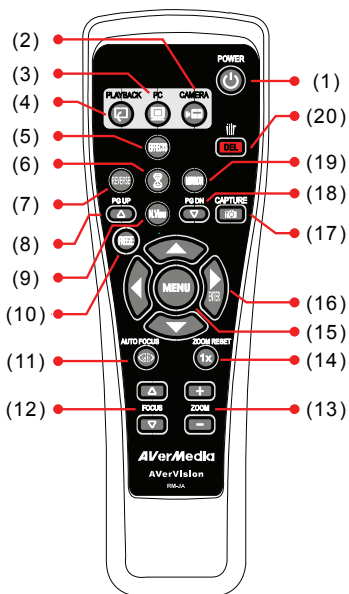

















Using the Infrared Remote Control

Use the AVerVision300AF Remote Control to enhance your presentation, switch between (3) three presentation modes and access various features. To use the remote control, first insert the batteries (2 size “AAA” batteries are provided) into the battery compartment at the back of the remote. Use the figure and descriptions below to help you use the remote control.



Name	Button	Function
(1) POWER		Turn the unit on/off.
(2) CAMERA MODE		Display image from the document camera.
(3) PC MODE		Display video signal from the RGB input port.
(4) PLAYBACK MODE		Display captured images from the built-in memory in either 16-thumbnail mode or full screen mode.
(5) EFFECTS		Change live image in BW, Negative or Color. (camera mode only)

Name	Button	Function
(6) TIMER		Display, start and hide the on-screen display timer. (See Timer Function for more details)
(7) REVERSE		Rotate the image by 180°. (camera mode only)
(8 & 18) PAGE UP/ DOWN	PG UP  PG DN 	Display previous and next set of 16-thumbnail images.
(9) NIGHT VIEW		Turn on/off Night View. Use Night View when you are presenting in a low-light condition. The display image appears in low frame rate.
(10) FREEZE		Toggle to pause or resume the display image. (camera mode only)
(11) AUTO FOCUS		Adjust the focus automatically.
(12) FOCUS △ / ▽	 FOCUS 	Adjust the focus manually.
(13) ZOOM +/-	 ZOOM 	Zoom in and zoom out the picture digitally in Playback mode. When it reaches the maximum AVERZOOM level of about 200%, you can still continue to digitally zoom in the image up to 1600%.
(14) ZOOM RESET		Return to normal view (1x).
(15) MENU		Pull up and exit the OSD main-menu and sub-menu.
(16) ▲ ▼ ◀ ▶ (▶ ENTER)		<ul style="list-style-type: none"> - Pan the mage to the left, right, up, down when zoom in mode. - Make a selection on the main menu and sub-menu. (See Menu Functions, for more details) - Make a selection in 16-thumbnail images and press  to view the selected image.

Name	Button	Function
(17) CAPTURE		Capture a still image. The captured image is saved in the built-in memory at 1024 x 768 resolution.
(19) MIRROR		Flip the image in Camera mode.
(20) DELETE		Remove the selected picture from the built-in memory permanently in Playback mode.

Touch Button Control Panel

The touch button control panel located on the top side of the AVerVision300AF provides quick access to commonly used functions.

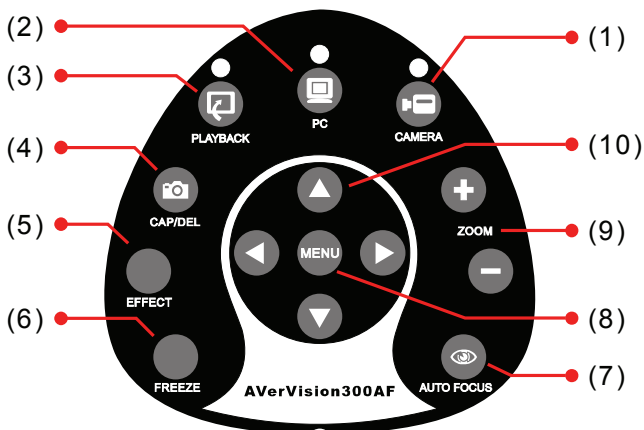

Function	Description
(1) CAMERA MODE	Display image from the document camera.
(2) PC MODE	Display video signal from the RGB input port.
(3) PLAYBACK MODE	Display captured images from the built-in memory in either 16-thumbnail mode or full screen mode.
(4) CAP/DEL	Capture a still image. The captured image is saved in the built-in memory at 1024 x 768 resolution. Remove the selected picture from the built-in memory permanently in Playback mode.
(5) EFFECT	Change live image in BW, Negative or Color. (camera mode only)

Function	Description
(6) FREEZE	Toggle to pause or resume the display image. (camera mode only)
(7) AUTO FOCUS	Adjust the focus automatically.
(8) MENU	Pull up and exit the OSD main-menu and sub-menu.
(9) ZOOM +/-	Zoom in and zoom out the picture digitally in Playback mode. When it reaches the maximum AVERZOOM level of about 200%, you can still continue to digitally zoom in the image up to 1600%.
(10) ▲ ▼ ◀ ▶	<ul style="list-style-type: none"> - Pan the mage to the left, right, up, down when zoom in mode. - Make a selection on the main menu and sub-menu. (See Menu Functions, for more details) - Make a selection in 16-thumbnail images and press  to view the selected image.

LED Panel

The LED on the front panel of AVerVision300AF indicates the status of the unit.

Color	Description
Green	The unit is operated with VGA output.
Orange	The unit is operated with TV output
Red	The unit is in standby mode.

Timer Function

The AVerVision300AF enables you to control the pace of your presentation by displaying the remaining time on the countdown screen. This merely serves as a reminder. When the time is up, the timer blanks at the top right corner only and the presentation screen will not be affected in any way.

To Set the Timer:

1. Press **MENU** to view on screen function selections.
2. Press **▲** or **▼** buttons to select **TIMER**.
3. Press **▶** or **◀** buttons to set a time value. You can set the time value up to 120 minutes.
4. After selecting a time value, press the **MENU** button to go back to the main menu.

To View and Start the Timer Countdown:

1. To display the previously set time value, press the **TIMER** button once. The AVerVision300AF automatically converts your settings to “hours:minutes:seconds” format. The maximum setting is 120 minutes.
2. To start the countdown, press the **TIMER** button again.
3. Once the countdown timer starts, you can toggle the countdown screen to display and hide it by pressing the **TIMER** button.



Transferring the captured image from AVerVision300AF to Computer

This enables you to transfer the captured image from the built-in memory to PC.



: The instruction below **MUST** be read and followed **BEFORE** connecting the USB cable.

1. **MUST** set the USB SELECT as Image Download before connecting the USB cable.

To set the USB SELECT as Mass Storage, press **MENU** > select **USB SELECT** and press (**▶**)> select **IMAGE DOWNLOAD** and press (**▶**).

2. When “IMG Download” appears at the bottom right corner of the screen, you may connect a USB cable between the doc cam and your computer.
3. Upon connecting the USB cable, the system automatically detects the document camera as a new removable disk.
4. You may now transfer the captured image from AVerVision300AF to your computer.

OSD Navigation Tree

VIDEO OUTPUT OSD





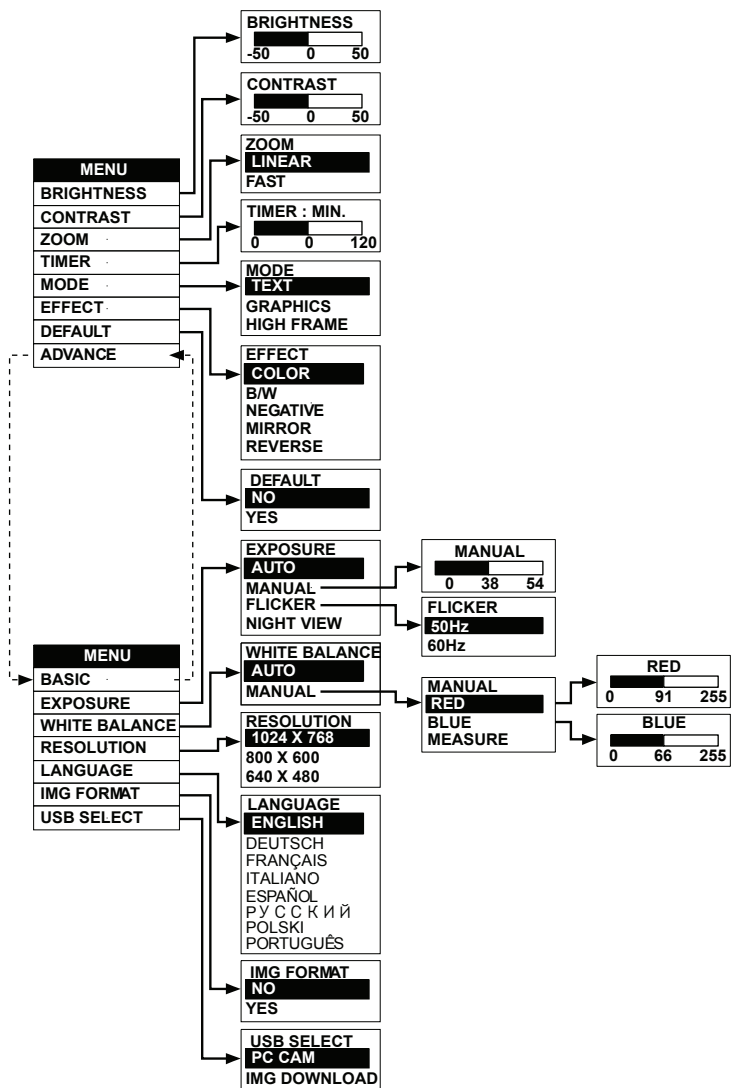

For TV output, RESOLUTION is not included in the menu list.



Menu Functions

The MENU functions of the AVerVision300AF enable you to fine-tune your screen display, set the timer, select OSD language and more. Press the **MENU** button to call up and exit from the main menu or sub-menu display. Use the **▲** or **▼** buttons to select the items in the menu list. Use the **▶** button to enter sub-menu. To adjust the setting, press **◀** or **▶** buttons.

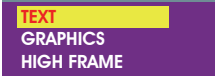
OSD Menu	Description
 <p>BRIGHTNESS</p>	<p>BRIGHTNESS</p> <p>Press ▶ or ◀ buttons to increase or decrease the brightness level and improve the visibility of the image. You can adjust the brightness level up to ± 50.</p>
 <p>CONTRAST</p>	<p>CONTRAST</p> <p>Press ▶ or ◀ buttons to emphasize or reduce the difference between light and dark conditions. You can adjust the contrast level up to ± 50.</p>
 <p>ZOOM</p>	<p>ZOOM</p> <p>Use ▲ or ▼ buttons to select between linear or fast zoom then press ▶ to make the selection. Using the linear zoom you can increase or decrease the zoom values by 10%. While using the fast zoom, the increments are by 100%. The maximum amount of zoom that you can view is 1600%.</p>
 <p>TIMER - MIN</p>	<p>TIMER</p> <p>Press ▶ or ◀ buttons to set a time value. You can set the time value up to 120 minutes. (Refer to the section, <i>Timer Function</i>, for more details.)</p>
 <p>MODE</p>	<p>MODE</p> <p>Use ▲ or ▼ buttons to select between Text, Graphics and High Frame modes.</p> <p>In text mode, the AVerVision300AF corrects the intensity of the adjacent pixel making it more uniform producing sharper and clearer images.</p> <p>While in graphics mode, the AVerVision300AF adjusts the gradient of the adjacent pixel making it appears to have a smooth image.</p> <p>While in real-time requirement, we suggest to select High Frame mode, which can more visually track animated objects and react quickly. (This mode is better to be used in good light.)</p>

OSD Menu	Description
<div style="background-color: #444; color: white; padding: 2px; text-align: center; font-weight: bold;">EFFECT</div> <div style="background-color: #222; color: white; padding: 5px;"> COLOR B/W NEGATIVE MIRROR ROTATE </div>	<p>EFFECT</p> <p>Use ▲ or ▼ buttons to display the image captured by the camera into negative, positive (true color), monochrome (black and white), mirrored image, or as a rotated image by 180°.</p>
<div style="background-color: #444; color: white; padding: 2px; text-align: center; font-weight: bold;">DEFAULT</div> <div style="background-color: #222; color: white; padding: 5px;"> NO YES </div>	<p>DEFAULT</p> <p>Use ▲ or ▼ buttons to select YES to restore to original factory default setting or NO to exit. Press ► to make the selection.</p>
<div style="background-color: #444; color: white; padding: 2px; text-align: center; font-weight: bold;">EXPOSURE</div> <div style="background-color: #222; color: white; padding: 5px;"> AUTO MANUAL FLICKER NIGHT VIEW </div>	<p>EXPOSURE</p> <p>Use ▲ or ▼ buttons to select between Auto and Manual.</p> <p>AVerVision300AF enables you to automatically or manually adjust the camera to determine how much light is required.</p>
<div style="background-color: #444; color: white; padding: 2px; text-align: center; font-weight: bold;">MANUAL</div> <div style="background-color: #222; color: white; padding: 5px;"> <div style="background-color: yellow; width: 100%; height: 15px; margin-bottom: 5px;"></div> <div style="display: flex; justify-content: space-between; width: 100%; font-size: 0.8em;"> 0 38 54 </div> </div>	<p>If you choose to manually adjust the exposure, press ► or ◀ buttons to adjust the exposure level.</p> <p>If you are presenting in a low-light condition, Night View enables the image of the object to appear as though under normal lighting conditions. The AVerVision300AF automatically adjusts the exposure to compensate for the adverse condition, but the captured image will appear to be in low frame rate.</p>
<div style="background-color: #444; color: white; padding: 2px; text-align: center; font-weight: bold;">FLICKER</div> <div style="background-color: #222; color: white; padding: 5px;"> 50 Hz 60 Hz </div>	<p>FLICKER</p> <p>Use ▲ or ▼ buttons to select between 50Hz or 60Hz. Some display devices cannot handle high refresh rates. The image will flicker a couple of times as the output is switched to another refresh rate.</p>
<div style="background-color: #444; color: white; padding: 2px; text-align: center; font-weight: bold;">WHITE BALANCE</div> <div style="background-color: #222; color: white; padding: 5px;"> AUTO MANUAL </div>	<p>WHITE BALANCE</p> <p>Use ▲ or ▼ buttons to select between Auto and Manual.</p> <p>AVerVision300AF enables you to automatically or manually adjust the camera to suit the lighting condition or color temperature. If you select to manually adjust the white balance, you can adjust the Red, Blue or use the system to measure the color temperature.</p>
<div style="background-color: #444; color: white; padding: 2px; text-align: center; font-weight: bold;">MANUAL</div> <div style="background-color: #222; color: white; padding: 5px;"> RED BLUE MEASURE </div>	<p>To obtain a more accurate color balance, place a sheet of white paper under the camera. Select MEASURE then press ► button to calibrate the color temperature. Wait until a "MEASURE OK" appears at the lower left corner of the presentation screen.</p>

OSD Menu	Description
<p>RESOLUTION</p> <p>1024 x 768 800 x 600 640 x 480</p>	<p>RESOLUTION</p> <p>Use ▲ or ▼ buttons to choose from 1024x768, 800x600 or 640x480 display resolution then press ► to make the selection.</p>
<p>LANGUAGE</p> <p>ENGLISH DEUTSCH FRANÇAIS ITALIANO ESPAÑOL РУССКИЙ POLSKI PORTUGUÊS</p>	<p>LANGUAGE</p> <p>Use ▲ or ▼ buttons to select from different languages then press ► to make the selection.</p>
<p>IMG FORMAT</p> <p>NO YES</p>	<p>IMG FORMAT</p> <p>Use ▲ or ▼ buttons to select No to exit or YES to format and delete all the images saved in the built-in memory then press ►.</p> <p>Please wait till the message "FORMAT" disappear to finish the process.</p>
<p>USB SELECT</p> <p>PC CAMERA IMG DOWNLOAD</p>	<p>USB SELECT</p> <p>Use ▲ or ▼ buttons to select USB functions between PC Camera and Image Download. In PC Camera mode, you can use AVerVision300AF as a computer webcam or with the bundled software as video recorder and capture still image.</p> <p>In Image Download mode, you can download the saved images from AVerVision300AF's built-in memory to your computer.</p>

RS-232C Diagram Connection

AVerVision300AF can be controlled using a PC through RS-232 connection.

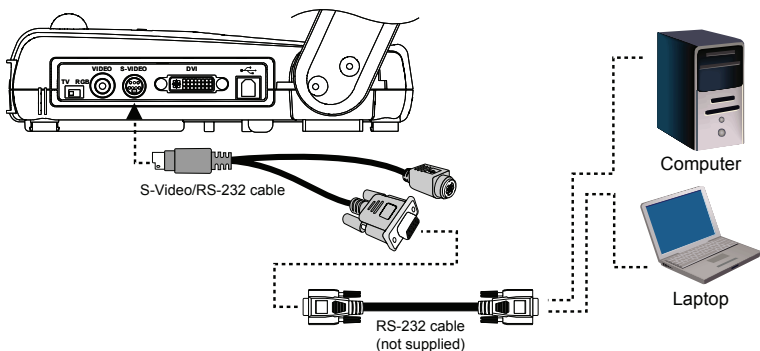

RS-232C Cable Spec

Make sure the RS-232 cable matches the cable spec design.

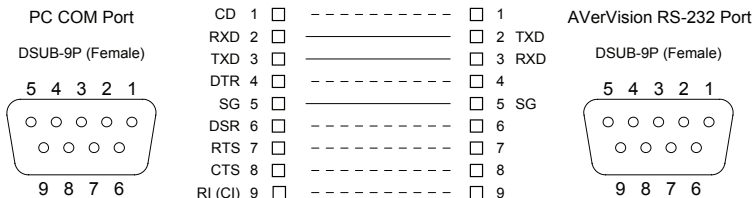

RS-232C Transmission Spec

- Star bit : 1 bit
- Data bit : 8 bit
- Stop bit : 1 bit
- Parity bit : None
- X parameter : None
- Baud rate(Communication speed) : 9600bps

RS-232C Communication Format

Start Code(1 Byte) : 0xFF
 Type Code(1 Byte) : 0x70
 DataLength Code(1 Byte) : 0x01
 Data Code(1 Byte) : See the Command Table for reference.
 CheckSum Code(1 Byte) : See the Command Table for reference.
 Format : Start + Type + DataLength + Data + CheckSum
 Example : 0xFF + 0x70 + 0x01+ 0x80 + 0xF1 (Command Power)

RS-232C Command Table

FUNCTION		DATA CODE	CHECKSUM CODE
POWER		0x80	0xF1
CAPTURE		0x90	0xE1
TIMER		0x8A	0xFB
NIGHT VIEW		0x8E	0xFF
FREEZE		0x91	0xE0
MODE SELECTION	CAMERA	0x83	0xF2
	PC	0x82	0xF3
	PREVIEW	0x81	0xF0
PREVIEW MODE	DELETE	0x88	0xF9
	PAGE UP	0x8D	0xFC
	PAGE DOWN	0x8F	0xFE

FUNCTION		DATA CODE	CHECKSUM CODE
ZOOM	IN	0x9A	0xEB
	OUT	0x9C	0xED
	ZOOM RESET	0x98	0xE9
FOCUS	AUTO FOCUS	0x97	0xE6
	NEAR	0x9B	0xEA
	FAR	0x99	0xE8
OSD	MENU	0x94	0xE5
	UP	0x92	0xE3
	DOWN	0x96	0xE7
	RIGHT	0x95	0xE4
	LEFT	0x93	0xE2
EFFECT	MIRROR	0x8B	0xFA
	ROTATE	0x89	0xF8
	COLOR / B.W / NEGATIVE	0x86	0xF7

Troubleshooting

This section provides many useful tips on how to solve common problems while using the AVerVision300AF.

There is no picture on the presentation screen.

1. Check all the connectors again as shown in this manual.
2. Check the on/off switch of the display output device.
3. Verify the setting of the display output device.
4. If you are presenting from a notebook or computer through the display output device, please check and switch the document camera source to PC Mode.

I have set up the AVerVision300AF and checked all the connections as specified in the manual, but I cannot get a picture on the preferred presentation screen.

1. Once the power cords are connected, the LED light turns RED as standby mode. Simply switch the AVerVision300AF "ON" by pressing the on/off switch until the LED light is blanking and turns GREEN.
2. The default camera display resolution setting is on 1024x768. If your output device does not support this resolution; no image can be projected. Simply press the MENU and RIGHT or LEFT button to the increase or decrease the resolution setting.
3. If your display output device is TV or any analog device, make sure the TV/RGB display switch is set to TV.

The picture on the presentation screen is distorted or the image is blurry.

1. Reset all changed settings, if any, to the original manufacturer default setting (Refer to the Menu Functions for more details and steps).

2. Use the Brightness and Contrast menu functions to reduce the distortion if applicable.
3. If you discover that the image is blurry or out of focus, press the Auto Focus button on the control panel or remote control.

There is no computer signal on presentation screen.

1. Check all the cable connections among the display device, AVerVision300AF and your PC.
2. Connect your PC to the AVerVision300AF first before you power on your computer.

The presentation screen does not show the exact desktop image on my PC or Notebook after I toggle from Doc Cam mode to PC mode.

1. Return to your PC or Notebook, place the mouse on the desktop and right click, choose "Properties", choose "Setting" tab, click on "2" monitor and check the box "Extend my Windows desktop onto this monitor".
2. Then go back one more time to your PC or Notebook and place the mouse on the desktop and right click again.
3. This time choose "Graphics Options", then "Output To", then "Intel® Dual Display Clone", and then choose "Monitor + Notebook".
4. After you follow these steps, you should be able to see the same desktop image on your PC or Notebook as well as on the presentation screen.

How do I download images from AVerVision300AF to a computer? Is it normal that AVerVision300AF will reset to camera mode after I download images and disconnect the USB cable?

Choose "IMG Download" from the Menu, and then connect the USB cable to download the captured and stored images from the AVerVision300AF to your computer. When finished, unplug the USB cable. The AVerVision300AF will automatically reset at camera mode.

Limited Warranty

For a period of time beginning on the date of purchase of the applicable product and extending as set forth in Section 6 of this Limited Warranty (the "Warranty Period"), AVerMedia Technologies, Inc. ("AVerMedia") warrants that the applicable product ("Product") substantially conforms to AVerMedia's documentation for the product and that its manufacture and components are free of defects in material and workmanship under normal use. "You" as used in this agreement means you individually or the business entity on whose behalf you use or install the product, as applicable. This limited warranty extends only to You as the original purchaser. Except for the foregoing, the Product is provided "AS IS." In no event does AVerMedia warrant that You will be able to operate the Product without problems or interruptions, or that the Product is suitable for your purposes. Your exclusive remedy and the entire liability of AVerMedia under this paragraph shall be, at AVerMedia's option, the repair or replacement of the Product with the same or a comparable product. This warranty does not apply to (a) any Product on which the serial number has been defaced, modified, or removed, or (b) cartons, cases, batteries, cabinets, tapes, or accessories used with this product. This warranty does not apply to any Product that has suffered damage, deterioration or malfunction due to (a) accident, abuse, misuse, neglect, fire, water, lightning, or other acts of nature,

commercial or industrial use, unauthorized product modification or failure to follow instructions included with the Product, (b) misapplication of service by someone other than the manufacturer's representative, (c) any shipment damages (such claims must be made with the carrier), or (d) any other causes that do not relate to a Product defect. The Warranty Period of any repaired or replaced Product shall be the longer of (a) the original Warranty Period or (b) thirty (30) days from the date of delivery of the repaired or replaced product.

Limitations of Warranty

AVerMedia makes no warranties to any third party. You are responsible for all claims, damages, settlements, expenses, and attorneys' fees with respect to claims made against You as a result of Your use or misuse of the Product. This warranty applies only if the Product is installed, operated, maintained, and used in accordance with AVerMedia specifications. Specifically, the warranties do not extend to any failure caused by (i) accident, unusual physical, electrical, or electromagnetic stress, neglect or misuse, (ii) fluctuations in electrical power beyond AVerMedia specifications, (iii) use of the Product with any accessories or options not furnished by AVerMedia or its authorized agents, or (iv) installation, alteration, or repair of the Product by anyone other than AVerMedia or its authorized agents.

Disclaimer of Warranty

EXCEPT AS EXPRESSLY PROVIDED OTHERWISE HEREIN AND TO THE MAXIMUM EXTENT PERMITTED BY APPLICABLE LAW, AVERMEDIA DISCLAIMS ALL OTHER WARRANTIES WITH RESPECT TO THE PRODUCT, WHETHER EXPRESS, IMPLIED, STATUTORY OR OTHERWISE, INCLUDING WITHOUT LIMITATION, SATISFACTORY QUALITY, COURSE OF DEALING, TRADE USAGE OR PRACTICE OR THE IMPLIED WARRANTIES OF MERCHANTABILITY, FITNESS FOR A PARTICULAR PURPOSE OR NONINFRINGEMENT OF THIRD PARTY RIGHTS.

Limitation of Liability

IN NO EVENT SHALL AVERMEDIA BE LIABLE FOR INDIRECT, INCIDENTAL, SPECIAL, EXEMPLARY, PUNITIVE, OR CONSEQUENTIAL DAMAGES OF ANY NATURE INCLUDING, BUT NOT LIMITED TO, LOSS OF PROFITS, DATA, REVENUE, PRODUCTION, OR USE, BUSINESS INTERRUPTION, OR PROCUREMENT OF SUBSTITUTE GOODS OR SERVICES ARISING OUT OF OR IN CONNECTION WITH THIS LIMITED WARRANTY, OR THE USE OR PERFORMANCE OF ANY PRODUCT, WHETHER BASED ON CONTRACT OR TORT, INCLUDING NEGLIGENCE, OR ANY OTHER LEGAL THEORY, EVEN IF AVERMEDIA HAS ADVISED OF THE POSSIBILITY OF SUCH DAMAGES. AVERMEDIA'S TOTAL, AGGREGATE LIABILITY FOR DAMAGES OF ANY NATURE, REGARDLESS OF FORM OF ACTION, SHALL IN NO EVENT EXCEED THE AMOUNT PAID BY YOU TO AVERMEDIA FOR THE SPECIFIC PRODUCT UPON WHICH LIABILITY IS BASED.

Governing Law and Your Rights

This warranty gives You specific legal rights; You may also have other rights granted under state law. These rights vary from state to state.



For warranty period, please refer to the warranty card.
